

SD4

DC-Ups series

Charging unit 120W

Output voltage 12V (13,6V) – 24V (27,2V)

Intelligent battery protection

Multi alarm output with variable delay



Technical Data	SD4-12120	SD4-24120
Input voltage	190 – 264V AC, 48-63Hz	
Output voltage	13,6VDC	27,2VDC
Output current	8A	4A
Power output	350 VA	350 VA
Max. Continual Load	60% of output current with batteries(25Ah) in circuit	
Efficiency	85% minimum at maximum load	
Peak inrush current	< 20A within 10ms	
Operating temperature	-10°C to +35°C	
Storage temperature	-40°C to +85°C	
Load regulation	0.5% for 0 to 100% load change	
Line regulation	0.2% for specified input voltage variation at 50% output power	
Switch frequency	40-50 kHz at maximum load	
Output ripple	100 mVp-p maximum at maximum load	
Output current limit	100% to 130% of max value.	
Output voltage limit	16V + - 6%	33V + - 6%
MTBF	Min. 100.000h at 25°C.	
Safety standard	EN 60950	
Safety class	I (With earth protection)	
Emission standards	EN50081-1	
Immunity standards	EN50082-1	
Harmonic emission	EN61000-3-2 , class A	
Power Factor Correction	Yes	
Battery surveillance	Automatic battery test every 24 hour (replacement notice after 3 years)	
Dimensions Weight	295 X 420 X 185 mm 7 KG (without battery)	
Mounting method	Wall Mount Cabinet	
IP class	IP20	
Output fuses	Positive 3 pcs 8A, Negative 3 pcs 8A (6,3x32mm)	
Battery fuse	Positive 1 pcs 10A (6,3x32mm)	
Terminals	Terminal Blocks (Rating 30A)	
Battery connection	2 X 3,3 sqmm RD/BK WIRE	
Max. Battery Capacity	2 x 12V 24Ah (26Ah)	

Technical Datasheet

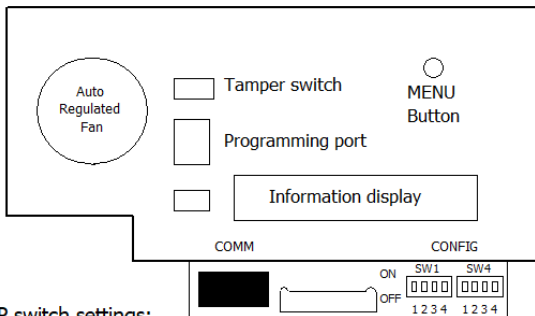

DIP switch settings:

SW1

1. Buzzer on/off
2. On and alarm relay is trigger if Main inn is interrupted more than 10min
3. On and alarm relay is trigger if Main inn is interrupted more than 30min
4. On when batteries is installed. Off if UPS is to be used only as power supply

SW4

1. On when power is 27,2V, Off when power is 13,6V
2. On if overload at 4Amp
3. On if overload at 8Amp
4. On if overload at 17Amp

Tamper switch will trigger alarm relay immediately when lid are removed

To disable/activate tamperswitch, hold menu button for 10 sek

The system test is the state of the battery every 24 hours, it is also possible to test battery manually.

Hi temp alarm will trigger alarmrelay immediately

Overload will trigger alarmrelay immediately

Trigger input

When trigger input is activated the output from the UPS are disabled, and the pin's marked with R are shorted together.

Maks current rating between contacts marked R is 5A

Cable size 0,2 - 1,5 mm²
24 - 16AWG

NO, NC & C

Alarm relay output
This relay state is ALARM

Alarm relay is triggered when an alarm occurse in the UPS system (no mains voltage, bad batteries etc.)

Max current is 5A

